

● General Description

It combines advanced trench MOSFET technology with a low resistance package to provide extremely low $R_{DS(ON)}$.

● Features

- Low $R_{DS(ON)}$ to minimize conductive loss
- Low Gate Charge for fast switching
- Low thermal resistance

● Application

- BLDC motor driver
- DC-DC
- Load switch

● Product Summary

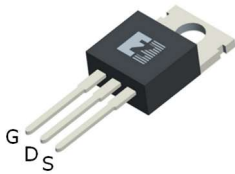

TO-220

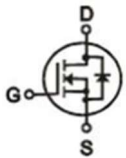

$V_{DS}=100V$

$R_{DS(ON)}=2mR$

$I_D=180A$



● Ordering Information

Part NO.	ZMS015N10HP
Marking	ZMS015N10H
Packing information	TUBE
Basic ordering unit (pcs)	1000

● Absolute Maximum Ratings ($T_A=25^{\circ}C$, unless otherwise specified)

Parameter	Symbol	Conditions	Min.	Max.	Unit
Drain-source voltage	V_{DS}		-	100	V
Gate-source voltage	V_{GS}		-20	20	V
Continuous drain current	I_D	$V_{GS}=10V, T_C=25^{\circ}C$	-	180	A
	I_D	$V_{GS}=10V, T_C=75^{\circ}C$	-	180	A
	I_D	$V_{GS}=10V, T_C=100^{\circ}C$	-	180	A
Pulsed drain current	I_{DM}	Pulsed; $t_p \leq 10 \mu s; T_C = 25^{\circ}C$;	-	720	A
Diode continuous current	I_S	$V_{GS}=0V, T_C=25^{\circ}C$	-	180	A
Diode pulse current	$I_{S,pulse}$	$V_{GS}=0V$, Pulsed, $t_p \leq 10 \mu s, T_C = 25^{\circ}C$	-	720	A
Total power dissipation	P_D	$T_C=25^{\circ}C$	-	375	W
Total power dissipation	P_D	$T_A=25^{\circ}C$	-	3.1	W
Operating junction temperature	T_J		-55	175	$^{\circ}C$
Storage temperature	T_{STG}		-55	175	$^{\circ}C$
Single pulse avalanche energy	E_{AS}	$L=0.1mH, V_{GS}=10V, R_g=25\Omega$,	-	500	mJ
		$L=0.5mH, V_{GS}=10V, R_g=25\Omega$,	-	900	mJ

ESD level (HBM)		CLASS 2
-----------------	--	---------

● Thermal resistance

Parameter	Symbol	Min.	Typ.	Max.	Unit
Thermal resistance, junction - case	R_{thJC}	-	-	0.4	°C/W
Thermal resistance, junction - ambient	R_{thJA}^{\circledast}	-	-	62	°C/W
Soldering temperature	T_{sold}	-	-	260	°C

● Electronic Characteristics ($T_j=25^{\circ}C$, unless otherwise specified)

Parameter	Symbol	Condition	Min.	Typ.	Max.	Unit
Drain-source breakdown voltage	BV_{DSS}	$V_{GS}=0V, I_D=250\mu A$	100	-	-	V
Gate threshold voltage	$V_{GS(th)}$	$V_{GS}=V_{DS}, I_D=250\mu A$	2	2.7	4	V
Drain-source leakage current	I_{DSS}	$V_{GS}=0V, V_{DS}=100V$	-	-	1	μA
Gate- source leakage current	I_{GSS}	$V_{GS}=\pm 20V, V_{DS}=0V$	-	-	100	nA
Static drain-source on resistance	$R_{DS(on)}$	$V_{GS}=10V, I_D=30A, T_j=25^{\circ}C$	-	2	2.4	m Ω
		$V_{GS}=10V, I_D=30A, T_j=175^{\circ}C$	-	3.8	-	m Ω
Forward transconductance	g_{FS}	$V_{DS}=5V, I_{SD}=10A$	-	41	-	S
Diode forward voltage	V_{FSD}	$V_{GS}=0V, I_{SD}=30A$	-	-	1.3	V

● Dynamic characteristics ($T_j=25^{\circ}C$, unless otherwise specified)

Parameter	Symbol	Condition	Min.	Typ.	Max.	Unit
Input capacitance	C_{iss}	$f=1MHz, V_{DS}=50V, V_{GS}=0V$	-	8906	-	pF
Output capacitance	C_{oss}		-	1884	-	pF
Reverse transfer capacitance	C_{rss}		-	31	-	pF
Gate resistance	R_g	$f=1MHz$	-	0.9	-	Ω
Total gate charge	Q_g	$V_{DD}=50V, I_D=30A, V_{GS}=10V$	-	151.2	-	nC
Gate-source charge	Q_{gs}		-	31.8	-	nC
Gate-drain charge	Q_{gd}		-	42.2	-	nC
Turn-on delay time	$t_{D(on)}$	$V_{GS}=10V, V_{DS}=50V, R_G=3.3\Omega, I_D=30A$	-	20	-	ns
Turn-on rise time	t_r		-	11	-	ns
Turn-off delay time	$t_{D(off)}$		-	48	-	ns
Turn-off fall time	t_f		-	38	-	ns
Reverse recovery time	t_{rr}		$V_{DD}=50V, di/dt=100A/\mu s, I_S=30A$	-	78	-
Reverse recovery charge	Q_{rr}		-	175	-	nC

● Fig.1 Gate-source voltage as a function of gate charge; Typical values; $T_j=25^\circ\text{C}$

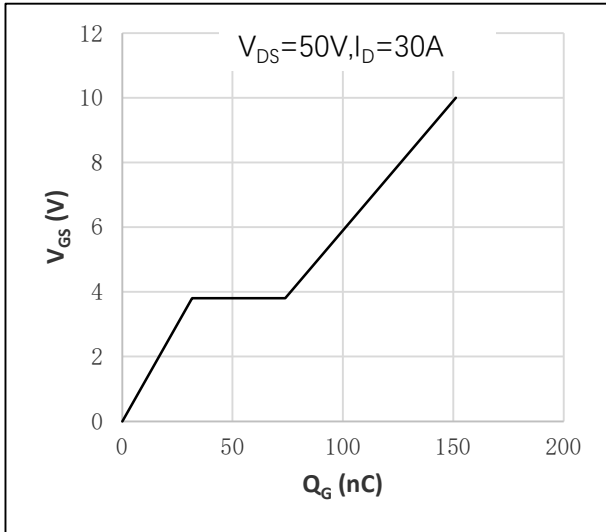

● Fig.2 Input, output and reverse transfer capacitances as a function of drain-source voltage; Typical values; $T_j=25^\circ\text{C}$

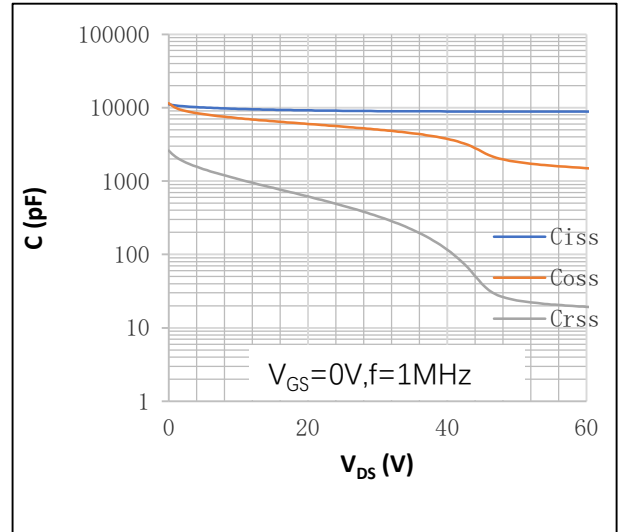

● Fig.3 Output characteristics: drain current as a function of drain-source voltage; Typical values; $T_j=25^\circ\text{C}$

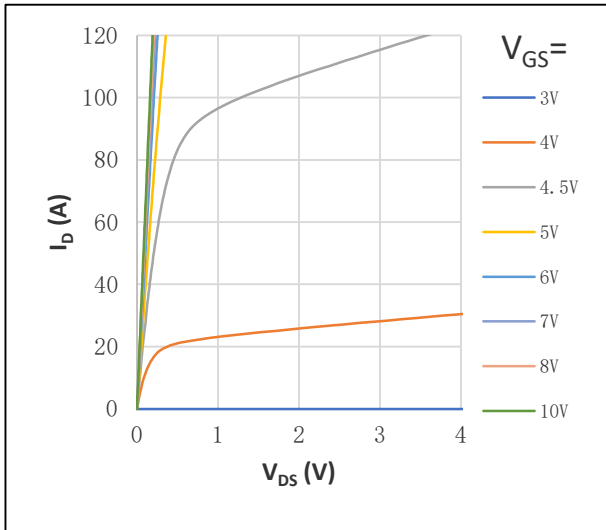

● Fig.4 Output characteristics: drain current as a function of drain-source voltage; Typical values: Expanded curve; $T_j=25^\circ\text{C}$

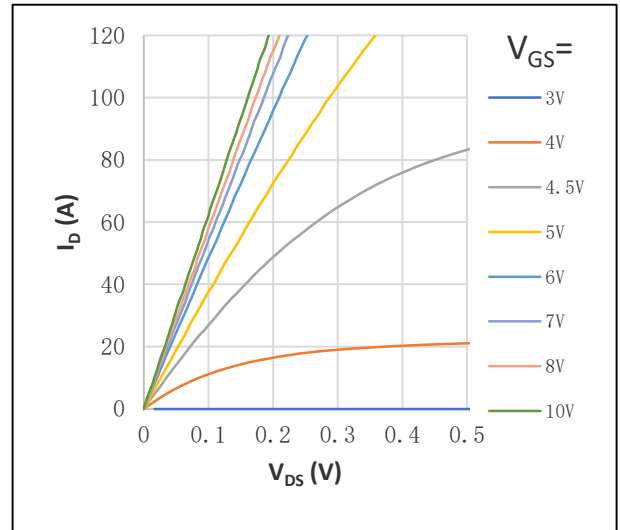

● Fig.5 Gate-source threshold voltage as a function of junction temperature; Typical values

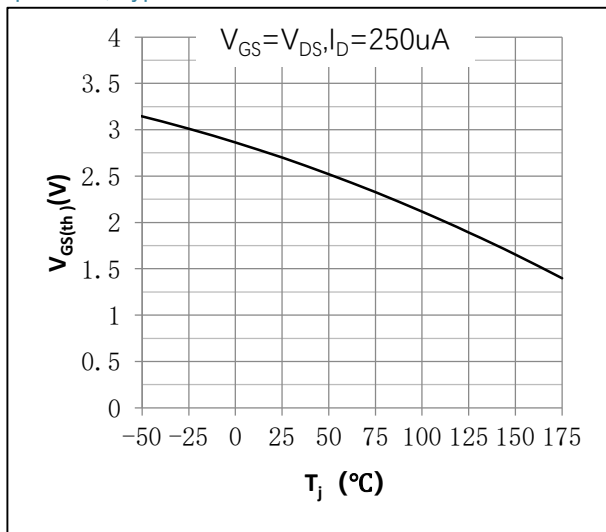

● Fig.6 Drain-source on-state resistance as a function of drain current; Typical values; $T_j=25^\circ\text{C}$

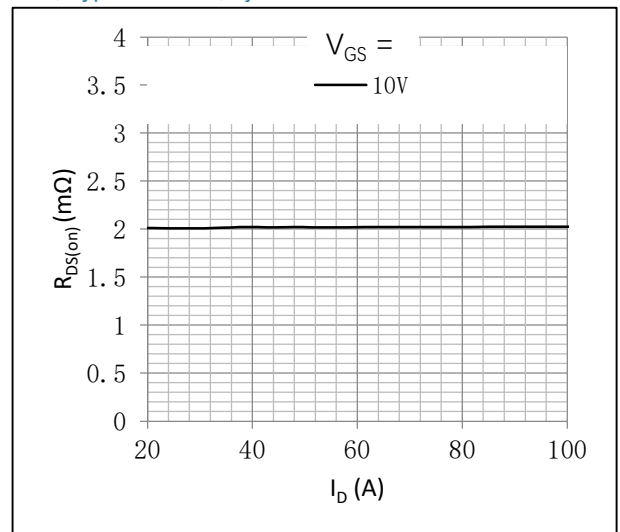

● Fig.7 Drain-source on-state resistance as a function of gate-source voltage; Typical values

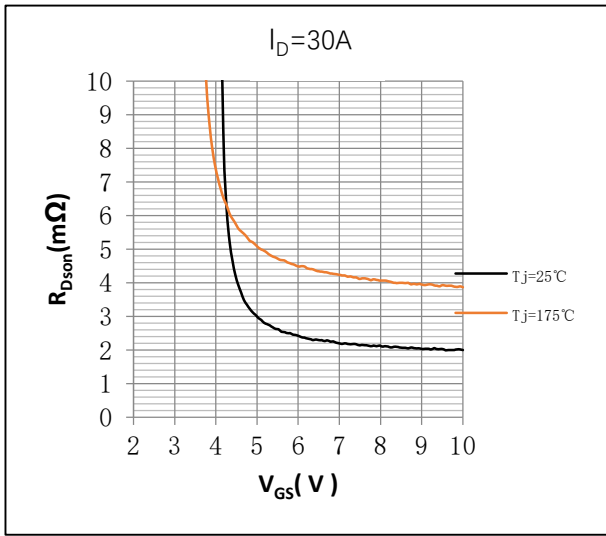

● Fig.8 Normalized drain-source on-state resistance factor as a function of junction temperature; Typical values Normalized On-Resistance = $R_{DS(on)}/R_{DS(on)}(25^{\circ}\text{C})$

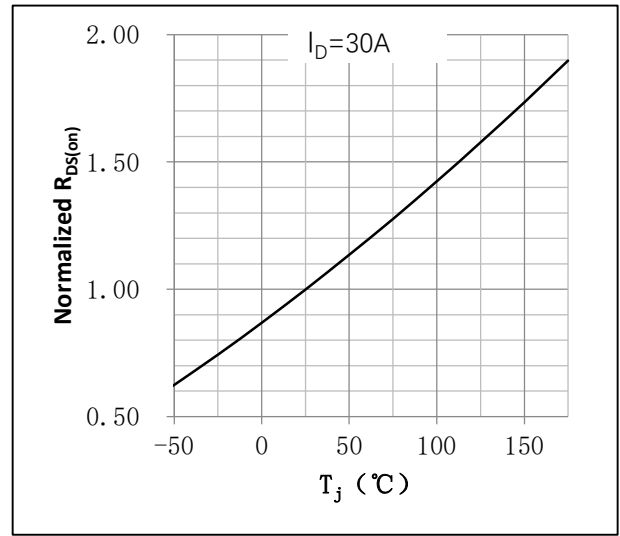

● Figure 9. Source (diode forward) current as a function of source-drain (diode forward) voltage; Typical values

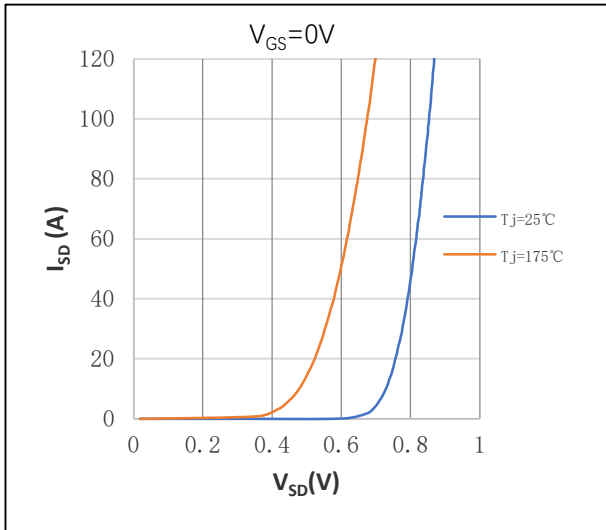

● Figure 10. Transfer characteristics: drain current as a function of gate-source voltage; Typical values

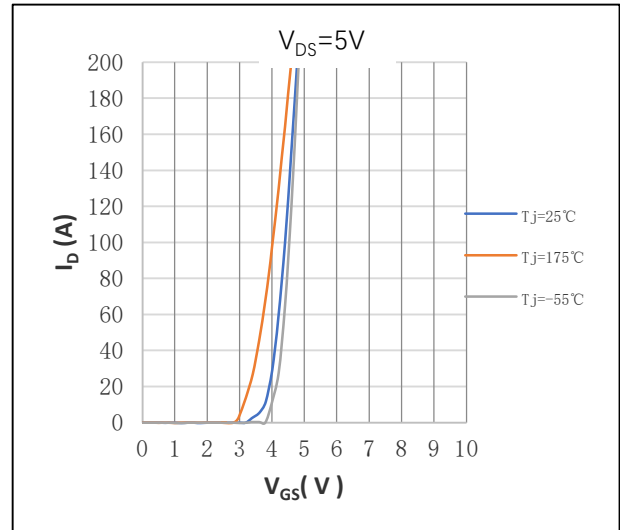

● Fig.11 Safe operating area: continuous and peak drain currents as a function of drain-source voltage; Calculative values

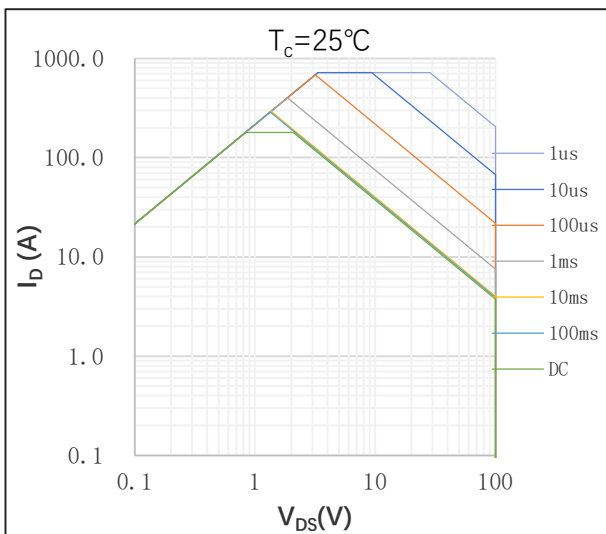

● Fig.12 Continuous drain current as a function of case temperature³; Calculative values

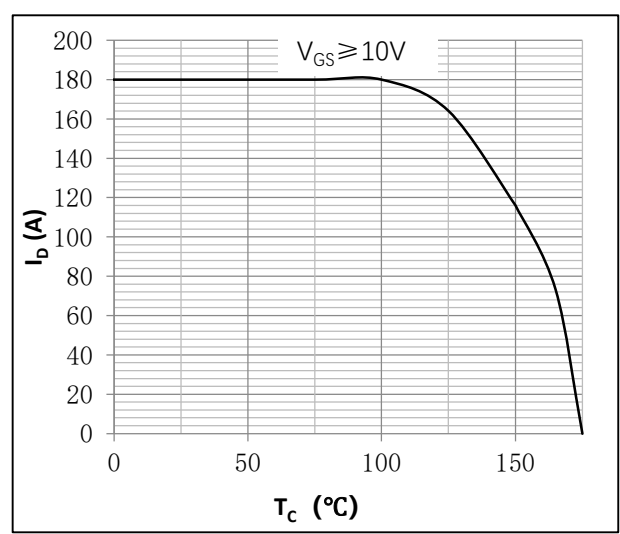

● Fig.13 Drain-source breakdown voltage as a function of junction temperature; Typical values Normalized $BV_{DSS} = BV_{DSS}/BV_{DSS}(25^{\circ}C)$

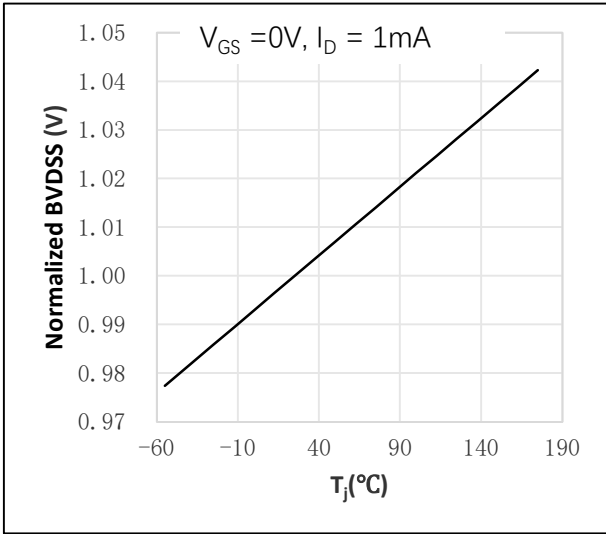

● Fig.14 Normalized total power dissipation as a function of case temperature; Calculative values Normalized Power Dissipation $= P_d/P_d(25^{\circ}C)$

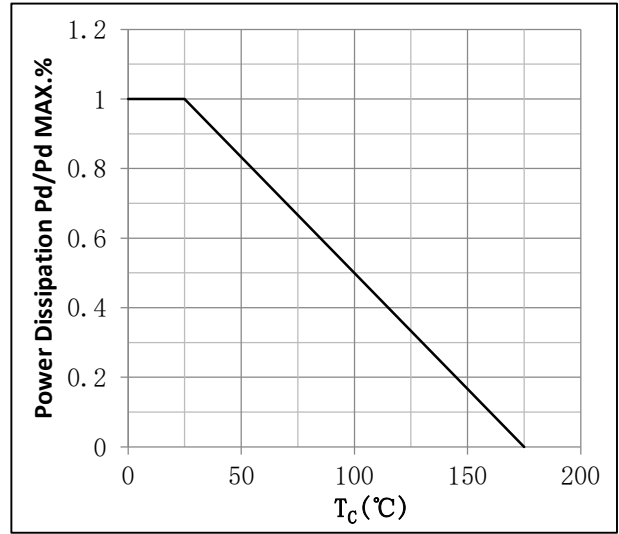

● Fig.15 Transient thermal impedance from junction to case as a function of pulse duration; max values

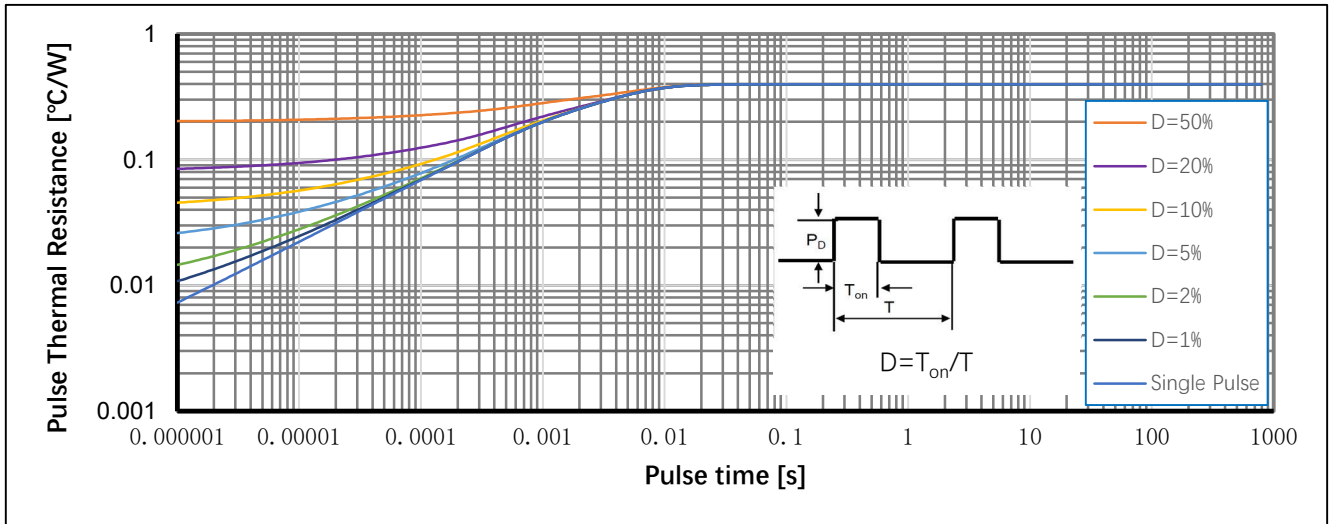

● Package Outline

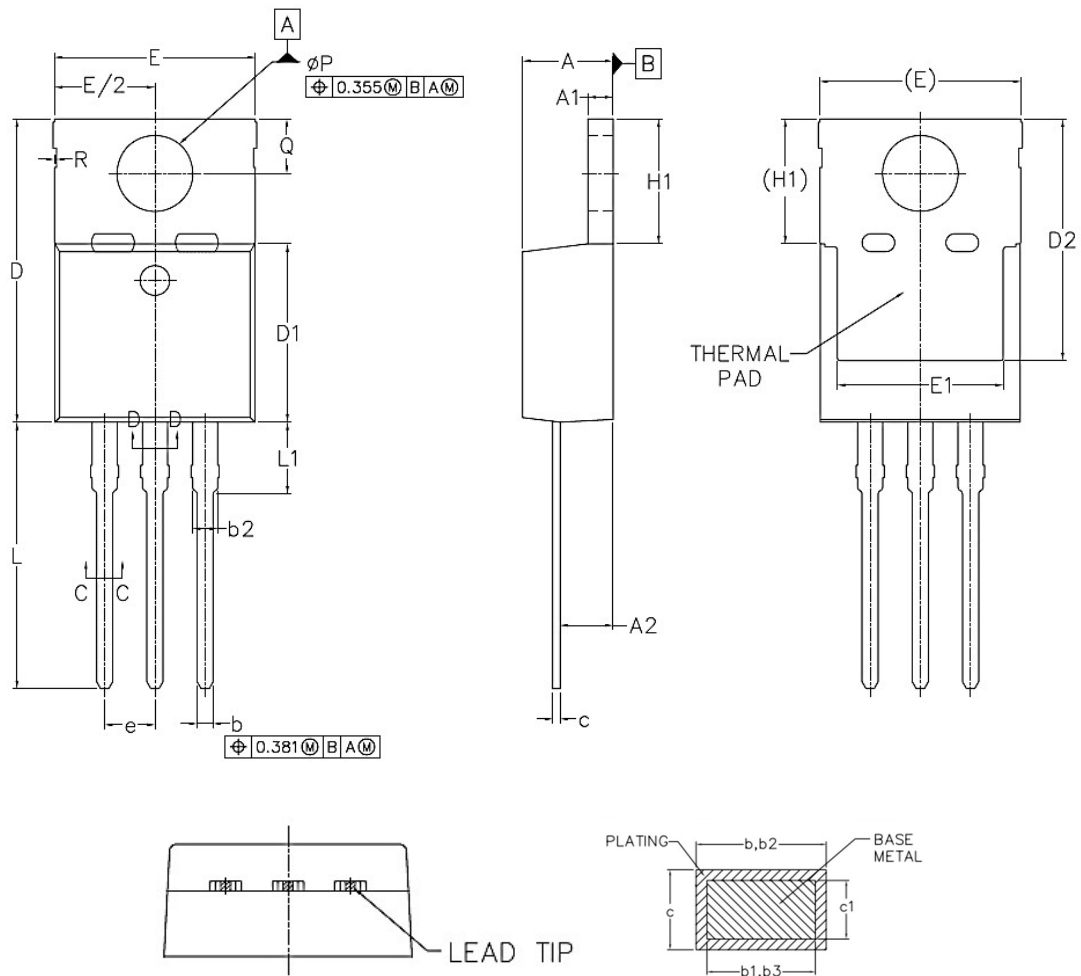

SYMBOL	COMMON	
	MM	
	MIN.	MAX.
A	3.556	4.826
A1	0.508	1.397
A2	2.032	2.921
b	0.381	1.016
b1	0.381	0.965
b2	1.143	1.778
b3	1.143	1.727
c	0.356	0.610
c1	0.356	0.559
D	14.224	16.510
D1	8.382	9.017
D2	12.042	12.878
E	9.652	10.668
E1	6.858	8.890
e	2.540 BSC.	
H1	5.842	6.858
L	12.700	14.732
L1	3.560	4.060
∅P	3.810	3.860
Q	2.540	3.048
R	0.127 BSC	

● Note

- ① Device mounted on FR-4 substrate PC board, 2oz copper, with thermal bias to bottom layer 1inch square copper plate;
- ② Practically the current will be limited by PCB, thermal design and operating temperature. $V_{GS}=10V$.

● Disclaimer

- Reproducing and modifying information of the document is prohibited without permission from ZMJ SEMICONDDUCTORS CO., LTD.
- ZMJ SEMICONDDUCTORS CO., LTD. reserves the rights to make changes of the content herein the document anytime without notification. Please refer to our website for the latest document.
- ZMJ SEMICONDDUCTORS CO., LTD. disclaims any and all liability arising out of the application or use of any product including damages incidentally and consequentially occurred.
- ZMJ SEMICONDDUCTORS CO., LTD. does not assume any and all implied warranties, including warranties of fitness for particular purpose, non-infringement and merchantability.
- Applications shown on the herein document are examples of standard use and operation. Customers are responsible in comprehending the suitable use in particular applications. ZMJ SEMICONDDUCTORS CO., LTD. makes no representation or warranty that such applications will be suitable for the specified use without further testing or modification.
- The products shown herein are not designed and authorized for equipments relating to human life and for any applications concerning life-saving or life-sustaining, such as medical instruments, aerospace machinery et cetera. Customers using or selling these products for use in such applications do so at their own risk and agree to fully indemnify ZMJ SEMICONDDUCTORS CO., LTD. for any damages resulting from such improper use or sale.
- Since ZMJ uses lot number as the tracking base, please provide the lot number for tracking when complaining.

● Revision History

Version	Date	Change
A	2024/4/28	New
B	2025/10/30	Apply new datasheet format.